

# QUICK PROGRAMMING GUIDE FOR ALL RTS MOTORS

Altus RTS 120 V / Sonesse 30™ 24V / Wirefree™ Roll Up LT-30RT Round Head & CORD Lift CT-32 Motors.

Please refer to individual instructions for more details

## Programming Mode

Before you begin





Motors are shipped without limit settings and transmitter ID's. Steps 1 to 7 must be completed to ensure proper shade programming and functionality. Power should ONLY be connected to current shade being programmed. All other shades should be disconnected from their respective power while programming

### STEP 1: Connect power

With the motor installed in shade, connect power to the motor (120V, or 12 V or 24V transformer or 12 V battery wand)







### STEP 2: Initiate programming

Press both  and  at the same time until the shade jogs. A jog is a brief up and down motion. In Programming Mode, the shade will move only when the  or  is held







### STEP 3: Check directions

Press  or . When pressing  product should go down or out. To change direction press and hold  (Stop) until the shade jogs. A jog is a brief up and down motion.





### STEP 4: Set the limits

Bring the shade to desired upper limit stop point. Press both  (Stop) and  until the motor moves, then release. (If the shade stops when the buttons are released take it back to the upper limit and repeat) Stop the motor when reaching the desired lower limit. You can adjust by pressing  or 



### STEP 5: Set the limits

Press both  (Stop) and  at the same time until the shade moves, then release. The shade will stop at the original upper limit.





### STEP 6: Confirm limit settings

Press an hold  (stop) until the shade jogs to confirm the limit settings. A jog is a brief up and down motion.



### STEP 7: Set user mode



Press and hold the programming button on the back of the transmitter until the shade jogs. The shade is now in User Mode. In User Mode, the shade will operate with a brief press on  or . Double check limit settings as a precaution.

## Adjusting the limits in User Mode

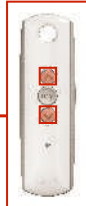

To change the lower limit  
Send the shade to it's current lower limit.





Press both  and  at the same time until the shade jogs. Adjust to a new lower limit position.

Press  until the shade jogs



To change the upper limit  
Send the shade to it's current upper limit.

Press both  and  at the same time until the shade jogs. Adjust to a new upper limit position.

Press  until the shade jogs

## Setting an Intermediate Position (Preferred Position)

### Setting

Press the  or  to operate shade. At the desired intermediate (preferred) position press  (Stop) to stop the shade.

Once the desired Intermediate position is reached, Press and hold  (stop) until the shade jogs. The Intermediate position is now added to memory





### Using

Send the shade to the intermediate position by pressing  (stop) From ANY shade position.

Note: Shade should be stationary prior to activating intermediate position function.

### Note

If shade is actively moving (in-motion)  Should be pressed twice. To Delete: Activate shade to intermediate position, then press and hold  (stop) for 5 seconds. Shade will jog to confirm deletion.

## Adding or deleting a Transmitter or a Channel



### Programmed Transmitter

STEP 1: Using already programmed transmitters select the transmitter (single channel) or the channel, (1-5) of a multi-channel transmitter.

STEP 2: Press and hold the programming button of that transmitter until the shade jogs.

### Transmitter to add or delete

STEP 3: Select the transmitter (single channel) or the channel, (1-5) of a multi-channel transmitter, to be added or deleted.

STEP 4: Press and hold the programming button of that transmitter until the shade jogs.



## Resetting WIREFREE™ ROLL UP MOTORS LT-30RT Round Head 12V DC

To delete all previous settings: Using a paper clip, press and hold the PROGRAM button located on the motor head. The LED will light then blink; release the button when the LED turns off. If you cannot see the LED, push and hold the programming button for 15 seconds, and then release the button. All transmitters and limits will be erased. (Motor is now reset to factory mode). Motor limits will need to be reestablished. See Programming Mode (step 4&5) for limit setting.

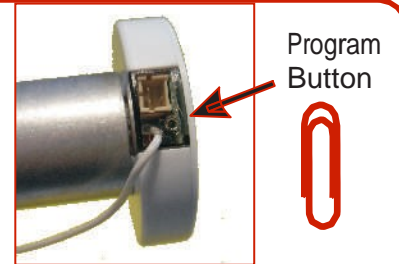

## Resetting WIREFREE™ CORD LIFT MOTORS CT-32 12V DC

To delete all previous settings: press and hold the PROGRAM button (approximately 15 seconds) until the LED blinks rapidly then extinguishes. All transmitters and limits will be erased. (Motor is now reset to factory mode). Motor limits will need to be reestablished. See Programming Mode (Step 4&5) for limit setting.

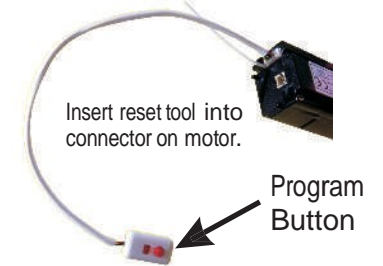

## Resetting Sonesse 30™ 24V DC

To delete all previous settings: Using a paperclip, press and hold the red PROGRAM button (approximately 15 seconds) until the shade jogs 3 times. All transmitters and limits will be erased. (Motor is now reset to factory mode). Motor limits will need to be reestablished. See Programming Mode (Step 4&5) for limit setting.



## Resetting TILT WIREFREE™ RTS MOTORS 12V DC

To delete all previous settings: Using a paperclip, press and hold the PROGRAM button, located on the top of the motor casing for 12 seconds. All transmitters and limits will be erased. (Motor is now reset to factory mode.) Motor limits will need to be reestablished. See Programming Mode (Step 4&5) for limit setting.

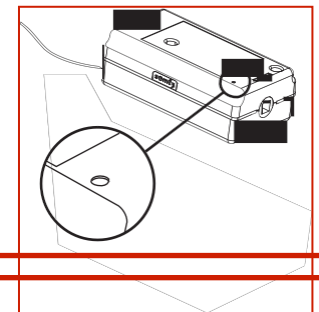

## Resetting Altus RTS 120 V AC

Perform a Dual Power Cut to delete all previous settings

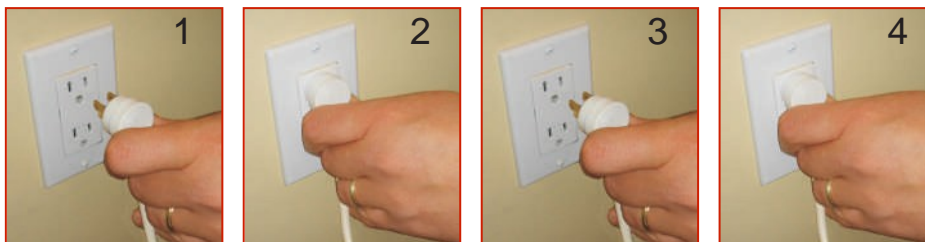

2 Seconds

10 Seconds

2 Seconds

Shade starts to move.

When the shade stops press and hold the programming button of any transmitter until the shade jogs twice.

Do not release the programming button until the jogging is complete or you will have to start the dual power cut from the beginning.



## Activating Step (Tilting) Feature for Sheer Shade Applications (With WIREFREE™ ROLL UP MOTORS LT-30RT Round Head only)

- 1) Press shade will travel to pre-set DOWN limit.
- 2) Press and hold until shade begins to "step" or tilt.
- 3) Release once new position is reached.